



CLEBER

MS2



User Manual

System: MS2 Modulator Board
Release: 2.0
Author: Simone Canepa

Summary.

SUMMARY.....	2
1 FIGURE INDEX.....	3
2 TABLE'S INDEX.....	4
3 SAFETY REGULATIONS.....	5
3.1 TREATMENT OF ELECTRICAL SHOCKS.....	5
3.2 TREATMENT OF ELECTRICAL BURNS.....	5
4 GENERAL DESCRIPTION.....	7
5 TECHNICAL SPECIFICATIONS.....	7
5.1 SYSTEM GENERAL SPECIFICATIONS.....	7
5.2 MECHANICAL SPECIFICATIONS.....	7
6 INSTALLATION.....	7
7 MECHANICS.....	8
7.1.1 Front Panel.....	8
7.1.2 Rear Panel.....	9
8 UNIVERSAL CHASSIS.....	10
8.1 USER INTERFACE.....	10
8.1.1 Main menu.....	10
8.1.2 Menu uProcessor (uP).....	11
8.1.2.1 MicroProcessor submenu.....	11
8.1.2.2 Menu Setup - System Time.....	11
8.1.2.3 Menu Setup - Touch Screen Calibration.....	11
8.1.2.4 Menu Setup - Reset.....	12
8.1.2.5 Menu Net - Network parameters.....	12
8.1.2.6 Menu Misc - General information 1/2.....	13
8.1.2.7 Menu Misc - General information 2/2.....	13
8.1.2.8 Menu Misc - Modules.....	13
8.1.3 Menu Power Supply (PS).....	14
8.2 WEB INTERFACE.....	15
8.2.1 Status.....	16
8.2.2 Tab Controller.....	16
8.2.2.1 Controller – Customer.....	16
8.2.2.2 Controller – Network.....	16
8.2.2.3 Controller – Traps/Relays Manager.....	17
8.2.2.4 Controller – Tools.....	20
8.2.2.5 Controller – Password management.....	21
8.2.3 Tab Slot.....	21
8.2.4 Tab Upgrade.....	22
8.2.5 Tab Log.....	22
8.2.6 Tab Statistic.....	24
9 MS2.....	26
9.1 TECHNICAL SPECIFICATIONS MS2.....	26
9.2 TFT.....	28
9.2.1 Menu Status – DVB-S2.....	28
9.2.2 Menu Status – DVB-S.....	30
9.2.3 Menu Status – DVB-T.....	30
9.2.4 Menu Status – ASI.....	31
9.2.5 Menu Config - General.....	32
9.2.6 Menu Config – DVB-S2.....	32
9.2.7 Menu Config – DVB-S2 ASI.....	33
9.2.8 Menu Config – DVB-S.....	34
9.2.9 Menu Config – DVB-T.....	34

9.2.10	Menu Mode Selection.....	35
9.2.11	Menu Info.....	36
9.3	WEB INTERFACE.....	36
9.3.1	DVB-T version.....	38
9.3.2	DVB-S/S2 version.....	40
9.3.3	DVB-S version.....	42
9.4	REAR PANEL.....	42

1 Figure Index.

FIGURE 1: RESUSCITATION DETAIL – 1.....	5
FIGURE 2: RESUSCITATION DETAIL – 2.....	5
FIGURE 3: RESUSCITATION DETAIL – 3.....	5
FIGURE 4: RESUSCITATION DETAIL – 4.....	5
FIGURE 5: RESUSCITATION DETAIL – 5.....	5
FIGURE 6: CLEBER FRONT PANEL.....	8
FIGURE 7: REAR PANEL CLEBER (NO SLOTS INSTALLED).....	9
FIGURE 8: POWER SUPPLY BACK PANEL (AC+DC VERSION).....	10
FIGURE 9: GENERAL MAIN MENU.....	10
FIGURE 10: MICROPROCESSOR SUBMENU.....	11
FIGURE 11: SYSTEM TIME SETTING MENU.....	11
FIGURE 12: VIRTUAL KEYPAD.....	11
FIGURE 13: TOUCH SCREEN CALIBRATION MENU.....	12
FIGURE 14: RESET MENU.....	12
FIGURE 15: NETWORK PARAMETERS MENU.....	12
FIGURE 16: GENERAL INFO MENU 1/2.....	13
FIGURE 17: GENERAL INFO MENU 2/2.....	13
FIGURE 18: GENERAL PURPOSE INFORMATION CONTROLLER.....	14
FIGURE 19: GENERAL PURPOSE INFORMATION TX.....	14
FIGURE 20: POWER SUPPLY MENU.....	14
FIGURE 21: ICON POWER SUPPLY WITH CONTINUOUS CURRENT, PRIMARY POSITION.....	15
FIGURE 22: ICON POWER SUPPLY WITH CONTINUOUS CURRENT, SECONDARY POSITION.....	15
FIGURE 23: ICON POWER SUPPLY WITH ALTERNATING CURRENT, PRIMARY POSITION.....	15
FIGURE 24: ICON POWER SUPPLY WITH ALTERNATING CURRENT, SECONDARY POSITION.....	15
FIGURE 25: WEB INTERFACE LOGIN PAGE.....	15
FIGURE 26: WEB CONTROLLER FORM – CUSTOMER INFO.....	16
FIGURE 27: WEB CONTROLLER FORM – NETWORK PARAMETERS MENU.....	17
FIGURE 28: WEB CONTROLLER FORM –TRAPS MANAGEMENT.....	17
FIGURE 29: WEB CONTROLLER FORM – SNMP TRAPS RECEIVERS.....	18
FIGURE 30: WEB CONTROLLER FORM – MAIL MANAGEMENT.....	18
FIGURE 31: WEB CONTROLLER FORM – RELAYS MANAGEMENT.....	19
FIGURE 32: WEB CONTROLLER FORM – GENERAL INFO AND TOOLS.....	20
FIGURE 33: WEB CONTROLLER FORM –PASSWORD MANAGEMENT.....	21
FIGURE 34: WEB SLOT FORM – PLUG IN BOARD SELECTION.....	21
FIGURE 35: WEB UPGRADE FORM - FIRMWARE UPDATE.....	22
FIGURE 36 : WEB LOG FORM – AVAILABLE LOG.....	22
FIGURE 37: WEB LOG FORM – AVAILABLE LOG EXPANDED.....	22
FIGURE 38: WEB LOG FORM – LOG.....	23
FIGURE 39: WEB STATISTIC FORM.....	25
FIGURE 40: MS2 BOARD PICTURE.....	26
FIGURE 41: INPUT STREAM PROCESSING FOR ONE STREAM OF THE MULTI-STREAM INTERFACE.....	29
FIGURE 42: STREAM BUFFER STATUS TABLE.....	29
FIGURE 43: DUMMY FRAME CHECK.....	29
FIGURE 44: BITRATE CHECK.....	29
FIGURE 45: DVB-S DSNG FEC ENCODER CORE STRUCTURE.....	30
FIGURE 46: MS2 STATUS DVB-S.....	30
FIGURE 47: BITRATE CHECK.....	30

FIGURE 48: MS2 STATUS DVB-T..... 31

FIGURE 49: BITRATE CHECK..... 31

FIGURE 50: MS2 STATUS ASI..... 31

FIGURE 51: MS2 CONFIG MODULATOR 32

FIGURE 52: MS2 CONFIG DVB-S2 33

FIGURE 53: WEB SLOT FORM - MS2 GENERAL INFO. 36

FIGURE 54: WEB SLOT FORM - MS2 GENERAL STATUS. 37

FIGURE 55: WEB SLOT FORM - MS2 OPERATIONAL MODE SETTING..... 37

FIGURE 56: WEB SLOT FORM - MS2 PRESET SETTINGS. 37

FIGURE 57: WEB SLOT FORM - MS2 STATUS (DVB-T). 38

FIGURE 58: WEB SLOT FORM - MS2 CONFIG (DVB-T)..... 39

FIGURE 59: WEB SLOT FORM - MS2 STATUS (DVB-S2). 40

FIGURE 60: WEB SLOT FORM - MS2 CONFIG (DVB-S2). 40

FIGURE 61: WEB SLOT FORM - MS2 CONFIG (INPUTS SETTING, MULTISTREAM). 41

FIGURE 62: WEB SLOT FORM - MS2 CONFIG (INPUTS SETTING, SINGLE STREAM OR ACM). 41

FIGURE 63: WEB SLOT FORM - MS2 CONFIG (DVB-S)..... 42

FIGURE 64: MS2 BACK PANEL DETAIL..... 42

2 Table's index.

TABLE 1: GENERAL SPECIFICATIONS..... 7

TABLE 2: CLEBER MECHANICAL SPECIFICATIONS 7

TABLE 3: REAR PANEL - EMPTY 9

TABLE 4: EQUIPMENT INFORMATION FOR CUSTOMERS..... 16

TABLE 5: EQUIPMENT INFORMATION FOR CUSTOMERS..... 16

TABLE 6: MAIL MANAGEMENT..... 18

TABLE 7: RELAYS MANAGEMENT 19

TABLE 8: DATE AND TIME..... 20

TABLE 9: RESET COMMAND..... 20

TABLE 10: DOWNLOAD SLOT CONFIGURATION..... 20

TABLE 11: UPLOAD SLOT CONFIGURATION..... 20

TABLE 12: DOWNLOAD MIB FILE 20

TABLE 13: CREATE TOKEN..... 21

TABLE 14: MS2 TECHNICAL SPECIFICATIONS 26

TABLE 15: MS2 INPUT FIFO STATUS 29

TABLE 16: MS2 DVB-S STATUS PARAMETERS MENU..... 30

TABLE 17: MS2 DVB-T STATUS PARAMETERS MENU..... 31

TABLE 18: MS2 DVB-S2 INPUTS STATUS PARAMETERS MENU 31

TABLE 19: MS2 CONFIG PARAMETERS MENU 32

TABLE 20: MS2 DVB-S2 CONFIG PARAMETERS MENU..... 33

TABLE 21: MS2 DVB-S2 INPUTS PARAMETERS MENU 33

TABLE 22: MS2 DVB-S PARAMETERS MENU..... 34

TABLE 23: MS2 DVB-T PARAMETERS MENU..... 35

TABLE 24: MS2 INFO MENU 36

TABLE 25: MS2 FACTORY INFO MENU..... 36

TABLE 26: MS2 GENERAL INFO 37

TABLE 27: MS2 STATUS PARAMETERS 37

TABLE 28: MS2 OPERATIONAL MODE PARAMETERS..... 37

TABLE 29: COFDM MODULATOR STATUS PARAMETERS MENU..... 38

TABLE 30: MS2 CONFIG (DVB-T) PARAMETERS..... 39

TABLE 31: MS2 INPUT FIFO AND MODULATOR PARAMETERS..... 40

TABLE 32: MS2 CONFIG DVB-S2 PARAMETERS - 1..... 40

TABLE 33: MS2 CONFIG DVB-S2 PARAMETERS-2 41

TABLE 34: MS2 CONFIG (INPUTS SETTING, SINGLE STREAM OR ACM) PARAMETERS 42

TABLE 35: MS2 CONFIG (DVB-S) PARAMETERS..... 42

3 Safety regulations.

The personnel engaged with the installation, the use and the maintenance of the equipment has to be familiar with the theory and practice of first aid.

3.1 Treatment of electrical shocks.

When the victim loses his consciousness:

Put into practice the following first aid principles.

- Position the victim lying down on his back on a rigid surface.
- Open the respiratory airways lifting up the neck and pushing down the front (Fig. 1).
- If necessary, open the mouth to check the respiration.
- In case the victim doesn't breathe, start immediately the artificial respiration (figure 2): bend the head, close the nostrils, attach the mouth to the victim one's and do 4 quick mouth-to-mouth respirations

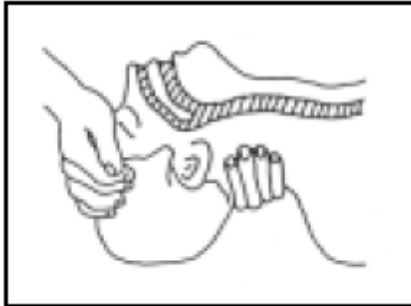

FIGURE 1: RESUSCITATION DETAIL – 1.



FIGURE 2: RESUSCITATION DETAIL – 2.

- Check the pulsation (Figure 3); in case of absence of pulsation, start immediately the cardiac massage (Figure 4) pressing the breastbone in the middle of the thorax (Figure 5).



FIGURE 3: RESUSCITATION DETAIL – 3.

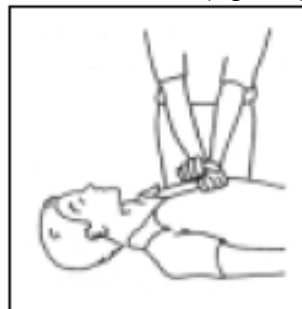

FIGURE 4: RESUSCITATION DETAIL – 4.

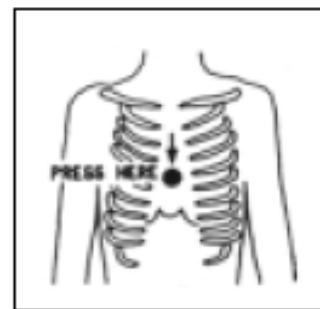

FIGURE 5: RESUSCITATION DETAIL – 5.

- When there is only one rescuer, he has to maintain a rhythm of 15 compressions alternated with 2 quick respirations.
- In case there are two rescuers, the rhythm should be one respiration each 5 compressions.
- Do not interrupt the cardiac massage during the artificial breathing
- Call a doctor as soon as possible

When the victim is conscious

- Cover up the victim with a blanket.
- Try to calm down the victim.
- Unbutton the cloche and lay down the victim.
- Call a doctor as soon as possible.

3.2 Treatment of electrical burns.

Large burns and cuts of the skin

- Cover up the interested area with a clean sheet or cloth.
- Do not open the blisters; remove the fabric and the parts of the clothes attached to the skin; apply a suitable ointment.
- Treat the victim according to the type of accident.
- Take the victim to the hospital as soon as possible.
- When the arms and legs are affected keep them raised.

When there is no doctor available within an hour and the victim is conscious and does not retch, give a liquid solution containing salt and sodium bicarbonate: 1 teaspoon of salt and half a teaspoon of sodium bicarbonate for each 250 ml of water.

Have the victim sip half a glass of the solution for four times and for 15 minutes.

Stop when retching.

Do not give any alcoholics

Less serious burns

- Apply cold (not frozen) gauzes using a clean as possible cloth.
- Do not open the blisters; remove the fabric and the parts of the clothes attached to the skin; apply a suitable ointment.
- When necessary, put on clean and dry clothes.
- Treat the victim according to the type of accident.
- Take the victim to the hospital as soon as possible.
- When the arms and legs are affected keep them raised.

4 General description.

5 Technical Specifications.

5.1 System General Specifications.

TABLE 1: GENERAL SPECIFICATIONS

Operative Temperature Range	-10°C ÷ 55°C
Management	<p>CLEBER:</p> <p>Front panel (Display TFT touchscreen)</p> <p>SNMP</p> <p>Web browser</p> <p>Head:</p> <p>Front panel (Display TFT touchscreen)</p>
Firmware upgrade	USB, WEB, FTP
Power supply	<p>Version 1:</p> <p>AC 90-260 V~ 50/60 Hz IEC 320</p> <p>Swappable</p> <p>Version 2:</p> <p>AC 90-260 V~ 50/60 Hz IEC 320 and</p> <p>DC 22 ÷ 65 V 2 pins socket</p> <p>Swappable</p> <p>Version 3:</p> <p>AC 90-260 V~ 50/60 Hz IEC 320 and</p> <p>DC 10 ÷ 36 V 2 pins socket</p> <p>Swappable</p> <p>Version 4:</p> <p>Dual redundant AC 90-260 V~ 50/60 Hz IEC 320</p> <p>Hot swappable</p> <p>Version 5:</p> <p>Dual redundant DC 10 ÷ 36 V 2 pins socket</p> <p>Hot swappable</p> <p>Version 6:</p> <p>Dual redundant DC 22 ÷ 65 V 2 pins socket</p> <p>Hot swappable</p>
Max power consumption	150 W
Max dissipation	160 W

5.2 Mechanical Specifications.

TABLE 2: CLEBER MECHANICAL SPECIFICATIONS

Rack	Standard 19" 1U
Width	482.5 mm
Height	43.65 mm
Depth	380.65 mm (without connectors) 357.80 mm (without connectors and front hangers)
Weight	< 7 Kg

6 Installation.

- Unpack the equipment and check first of all check if there are any damages due to the transport.
- The box should contain:

- The CLEBER
 - 1 or two AC supply cable (depending on number and type of power supplies purchased)
 - 1 or two DC supply cable, equipment adapted connector on one side, free wires at other end (depending on number and type of power supplies purchased)
 - An envelope containing:
 - Reserved web and display passwords
 - USB pen with Token for display access and user manual
- Install the equipment in a rack cabinet. A one-unit space is requested. Verify that there is enough space between other functioning equipment generating high temperatures and that there are no obstructions in the ventilation. (The functioning is guaranteed in a temperature range from -10 °C ÷ +55 °C).
 - The equipment must be correctly grounded, to guarantee a secure functioning.
 - Connect to the correct power tension reading the information on the manual or on the label attached to each equipment, containing the serial number.
 - Connect the network cable to the plug on the rear of the equipment or connect the battery cable to the related connector. The last used configuration will be loaded.
 - Connect the flange(s) on the rear panel (or N connectors, depending on frequencies) of the equipment to the waveguide/cable for the connection to the branching system and the antenna.
 - Setup the equipment according to the needs consulting the user manual.

7 Mechanics.

7.1.1 Front Panel.



FIGURE 6: CLEBER FRONT PANEL.

TABLE 86: FRONT PANEL DESCRIPTION.

Tag	Description	Function				
1	DB15 Connector	<p style="text-align: right;">J2 CONNECTOR DB15</p> <table border="1" style="margin-left: auto; margin-right: auto;"> <thead> <tr> <th>Pin</th> <th>Function</th> </tr> </thead> <tbody> <tr> <td>1</td> <td>Not connected</td> </tr> </tbody> </table>	Pin	Function	1	Not connected
Pin	Function					
1	Not connected					

		2	Debug serial Rx Pin
		3	Ground
		4	Relay 2, Normally open contact
		5	Reset pin for In-System-Programming modality
		6	+3.3V
		7	0-5V controlled voltage for analogue remote control; programmable upon customer request.
		8	Debug serial RTS Pin
		9	Debug serial Tx Pin
		10	Relay 1-2-3 Common Contact
		11	Relay 1, Normally open contact
		12	Relay 3, Normally open contact
		13	Not connected
		14	0-5V controlled voltage for analogue remote control; programmable upon customer request.
		15	Debug serial CTS Pin
2	RJ-45 Connector	Port Ethernet 10/100 for Management	
3	USB Connector	USB pen drive connection for firmware upgrade and token connection (read/write accede to TFT).	
4	Led green	Power supply on	
5	Three colours led	Green: ok Yellow: warning Red: alarm	
6	Display touchscreen	TFT	User Interface
7	Connector RJ-45	Fast Ethernet Port for Debug and equipment extensions	

7.1.2 Rear Panel.

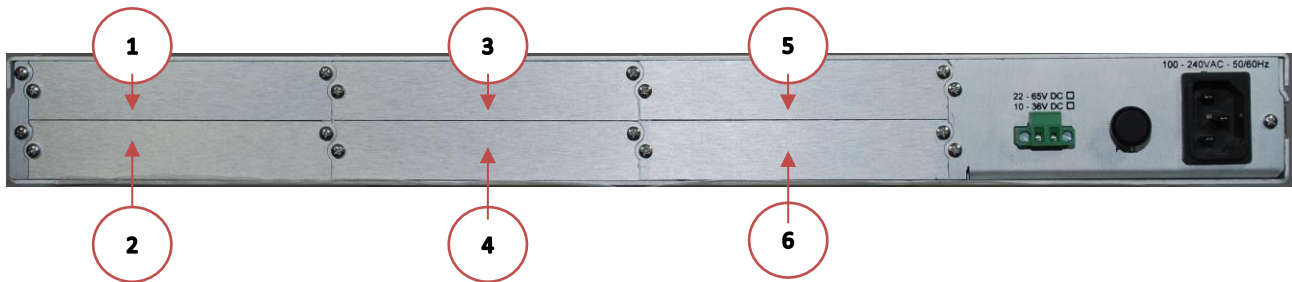

FIGURE 7: REAR PANEL CLEBER (NO SLOTS INSTALLED).

TABLE 3: REAR PANEL - EMPTY

Item	Description	Function
1	Blind Panel	Slot number 3
2	Blind Panel	Slot number 4
3	Blind Panel	Slot number 2
4	Blind Panel	Slot number 5
5	Blind Panel	Slot number 1
6	Blind Panel	Slot number 6

7.1.2.1.1 PSU.

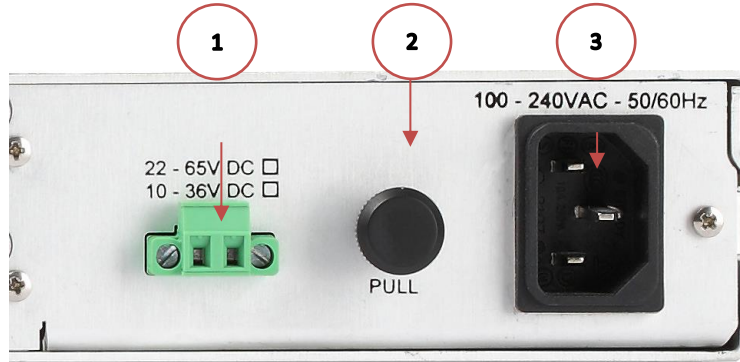

FIGURE 8: POWER SUPPLY BACK PANEL (AC+DC VERSION).

TABLE 91: PSU CONNECTORS DESCRIPTION

Tag	Description	Function
1		DC input (check input range flagged) before connection. Polarity independent
2	PULL	Hanging knob for swapping.
3	100-240VAC - 50/60Hz	IEC 320 socket for AC input.

8 Universal chassis.

8.1 User interface.

The user interface consists of a general alarm led and a graphical TFT display with **TOUCH SCREEN** function (for more comfortable use, a stick is available in a compartment located in the front panel, see Figure 6).

According to equipment configuration (i.e. optional boards installed) related menu are shown.

In order to have a read/write privilege and thus modify the configuration of the equipment, it's required the connection of a USB pen with the right token to the USB port in the front panel; on the other end, it's required to digit a numeric password while trying to modify one parameter (the password is tied to the customer's name and it's notified at delivery).

8.1.1 Main menu.

At equipment switch on, after embedded software boot, display shows the main menu, according to the configuration, as can be seen in figure below. This menu shows the equipment block diagram, for an easy and intuitive access to modules parameters according to their function; on every active area, one or more circles symbolizing alarm led are shown, eventually red or green depending on the status of the related block.

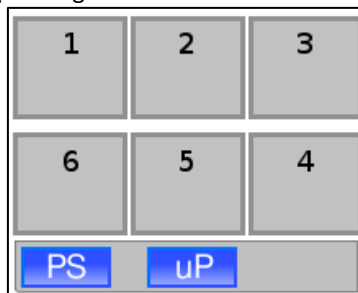



FIGURE 9: GENERAL MAIN MENU.

Active areas:

- 1
- 2
- 3
- 4
- 5
- 6
- PS 
- uP 

8.1.2 Menu uProcessor (uP).

8.1.2.1 MicroProcessor submenu.

The submenu let a fast access to the elements to be controlled; icons meaning, concerning different sections, is intuitive.

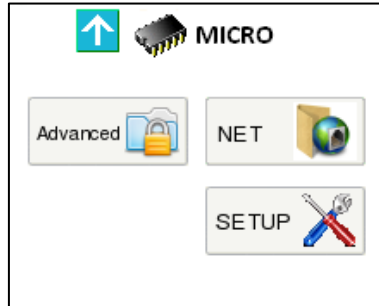

FIGURE 10: MICROPROCESSOR SUBMENU.

8.1.2.2 Menu Setup - System Time.

This menu let the user set right time and date, used by the system for alarm logging. Information about system time is preserved by the battery of the *Real Time Clock*.

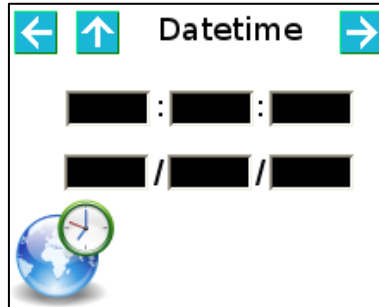





FIGURE 11: SYSTEM TIME SETTING MENU.

Active areas:

- Directional arrow “UP”  to go back to main menu.
- Directional arrows “LEFT”  and “RIGHT”  to browse microprocessor menu.
- Every text box which opens a virtual keypad to enter information.

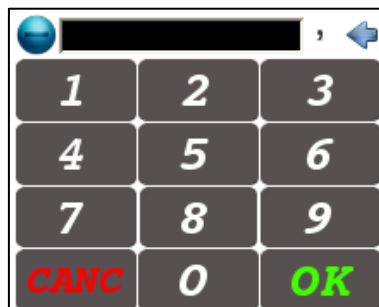

FIGURE 12: VIRTUAL KEYPAD.



8.1.2.3 Menu Setup - Touch Screen Calibration.

This menu let the user calibrate the Touch Screen function. It’s recommended to use the stick provided with the equipment to touch the red cross, three times as required by the system, after **Calibrate** button pushing.



FIGURE 13: TOUCH SCREEN CALIBRATION MENU.

Active areas:

- Directional arrow "UP"  to go back to main menu.
- Directional arrows "LEFT"  and "RIGHT"  to browse microprocessor menu.

8.1.2.4 Menu Setup - Reset.

This menu let the user reset each microcontroller and FPGA of the equipment.

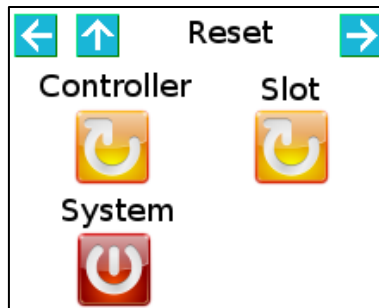





FIGURE 14: RESET MENU.

Active areas:

- Directional arrow "UP"  to go back to main menu.
- Directional arrows "LEFT"  and "RIGHT"  to browse microprocessor menu.
- Reset icons.

SLOT reset will eventually restart modem and data interface; CONTROLLER reset just reboot system supervisor, SYSTEM reset is the complete reset of the equipment.

8.1.2.5 Menu Net - Network parameters.

This menu let the user modify management port network parameters; in detail, it is possible to set IP address, Subnet Mask and Gateway IP. MAC Address is read-only.

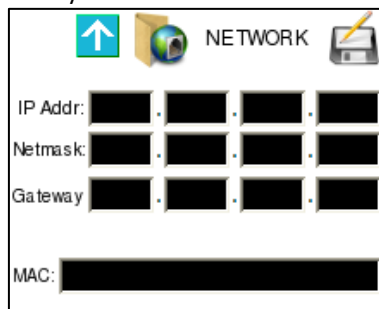



FIGURE 15: NETWORK PARAMETERS MENU.

Active areas:

- Directional arrow "UP"  to go back to main menu.

- Directional arrows “LEFT”  and “RIGHT”  to browse microprocessor menu.
- Every text box, which opens the virtual keypad to insert characters.

8.1.2.6 Menu Misc - General information 1/2.

This menu shows general purpose information, such as:

- Model
- Serial Number
- Part Number

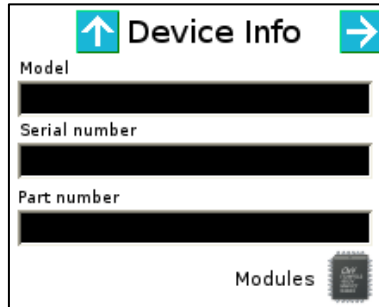



FIGURE 16: GENERAL INFO MENU 1/2.

Active areas:

- Directional arrow “UP”  to go back to main menu.
- Directional arrow “RIGHT”  to browse microprocessor menu.
- Modules icon.

8.1.2.7 Menu Misc - General information 2/2.

This menu shows general purpose information, such as:

- Customer name (two rows)
- Installation site (Loc.)

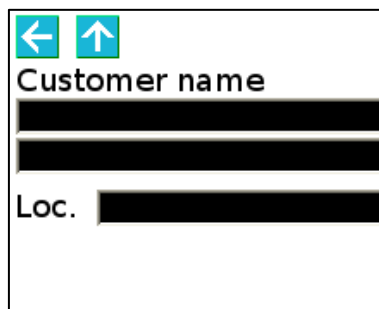





FIGURE 17: GENERAL INFO MENU 2/2.

Active areas:

- Directional arrow “UP”  to go back to main menu.
- Directional arrows “LEFT”  and “RIGHT”  to browse microprocessor menu.

8.1.2.8 Menu Misc - Modules.

8.1.2.8.1 Menu Misc - Modules - Controller.

This menu shows controller general purpose information such as:

- Model
- Version
- Revision

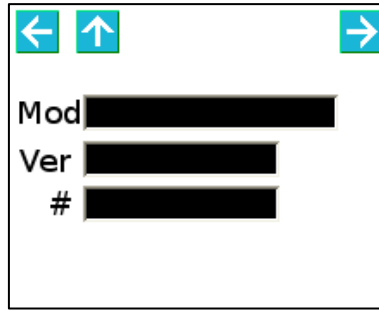





FIGURE 18: GENERAL PURPOSE INFORMATION CONTROLLER.

Active areas:

- Directional arrow “UP”  to go back to main menu.
- Directional arrows “LEFT”  and “RIGHT”  to browse microprocessor menu.

8.1.2.8.2 Menu Misc - Modules - Tx.

This menu shows transmitter general purpose information such as:

- Model
- Version
- Revision

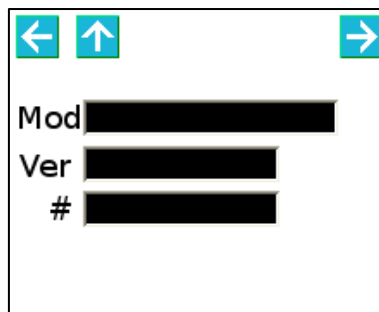





FIGURE 19: GENERAL PURPOSE INFORMATION TX.

Active areas:

- Directional arrow “UP”  to go back to main menu.
- Directional arrows “LEFT”  and “RIGHT”  to browse microprocessor menu.

8.1.3 Menu Power Supply (PS).

The Power Supply menu allows verifying whether both power supply modules are fed, what type of feeding they are receiving and whether the secondary voltages are correct (+5V and +6V).

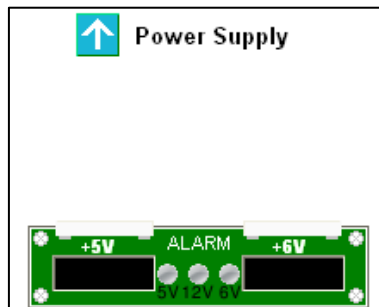

FIGURE 20: POWER SUPPLY MENU.

Active areas:

- Directional arrow “UP”  to go back to main menu.

There is as well a general alarm indicator in case one of the voltage values is not being respected.

The upper zone of the menu is dynamically filled by the icon of the corresponding power supply module, which can be in alternating or continuous current. It is hence possible to see the different combinations reported in the following figures.

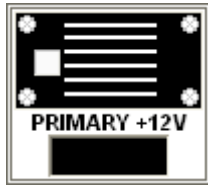

FIGURE 21: ICON POWER SUPPLY WITH CONTINUOUS CURRENT, PRIMARY POSITION.



FIGURE 22: ICON POWER SUPPLY WITH CONTINUOUS CURRENT, SECONDARY POSITION.

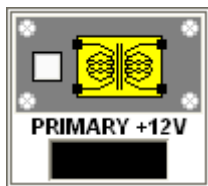

FIGURE 23: ICON POWER SUPPLY WITH ALTERNATING CURRENT, PRIMARY POSITION.



FIGURE 24: ICON POWER SUPPLY WITH ALTERNATING CURRENT, SECONDARY POSITION.

8.2 WEB Interface.

CLEBER is equipped with a WEB interface for an easier and intuitive monitoring and equipment configuration. The connection to Web server can be achieved through RJ-45 connector in the front panel; with a very common *Web browser* (like Internet Explorer, Mozilla Firefox, Google Chrome, Opera, Safari...) it is possible to check equipment status and verify performances even remotely simply writing in the address bar the IP address of the equipment. In order to check the IP address, please refer to par. 8.1.2.5.

Important Note: Default IP address is 192.168.10.150.

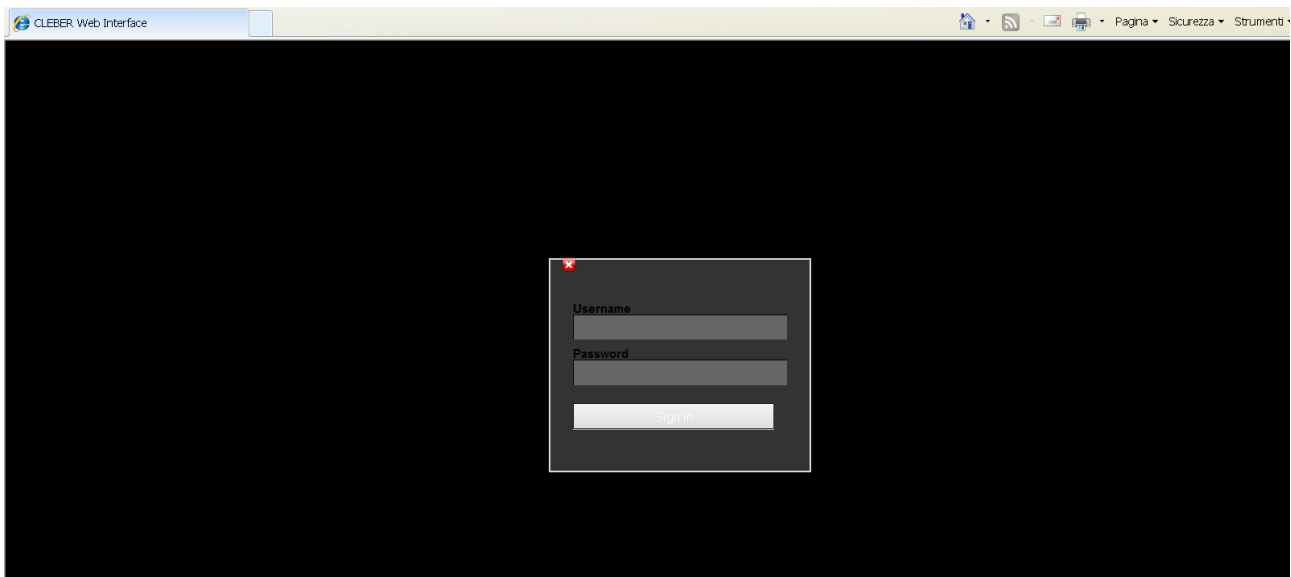

FIGURE 25: WEB INTERFACE LOGIN PAGE

Figure 25 shows the login page of the Web interface, which let the user accede to after successful insertion of username and password. Default passwords are tied to the customer name and they are generated automatically during testing sessions; credentials are delivered with the goods with the documentation.

Three access levels are available:

1. User, with username **user** (read-only access to)
2. Power user, with username **puser** (read/write access to)
3. Administrator, with username **admin** (read/write and special functions access to)

Passwords can be modified, depending on the credentials, by the customer in related section (see par. 8.2.2.4).

8.2.1 Status.

Once the login process has been validated, the general status page opens; it let the user immediately check alarmed parts; the page is divided into 2 parts:

- The upper part reports Controller general information and power supply’s
- The lower part, divided into up to 6 different modules according to the number of optional boards installed, is explained in 9.3.

8.2.2 Tab Controller.

Tab web concerning Controller is composed by five frames:

1. Customer.
2. Network.
3. Traps Manager.
4. Tools.
5. Password Management.

8.2.2.1 Controller – Customer.

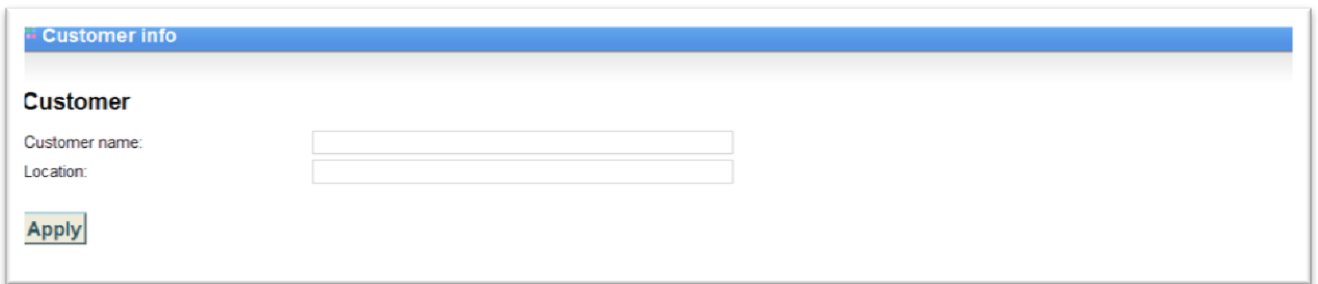

FIGURE 26: WEB CONTROLLER FORM – CUSTOMER INFO.
TABLE 4: EQUIPMENT INFORMATION FOR CUSTOMERS.

Customer name	Customer name.
Location	Installation site.

8.2.2.2 Controller – Network.

This frame let check and modify network parameters of the user interface.

Ip Address, Netmask and Gateway Address can be modified by the user writing in the dedicated text box while Mac Address is read-only. Moreover, it’s possible to configure a DNS, a NTP server IP address, the Time Zone and the Country where the equipment is installed.

TABLE 5: EQUIPMENT INFORMATION FOR CUSTOMERS.

DHCP	Enable DHCP protocol to get network configuration automatically (if supported by user network; please contact your network administrator for further details).
IP Address	Equipment IP Address
Netmask	Equipment IP Subnet Mask
Gateway	Gateway IP Address
MAC address	Equipment MAC Address (read only)
Domain Name Server	DNS IP Address
NTP Server	NTP Server IP Address
Time Zone	Selection of Time Zone for Time synchronization
Country	Selection of Country for Time synchronization

Network Management

Network Management

DHCP:

Ip address: 192.168.9.232

Netmask: 255.255.240.0

Gateway: 192.168.0.254

MAC address: 84:7E:40:AB:05:12

Domain name server: 8.8.8.8

NTP server: ntp1.inrim.it

Timezone (correction for NTP sync)

Select your country and timezone

Time zone: Europe/Rome

Country: Italy

Apply

FIGURE 27: WEB CONTROLLER FORM – NETWORK PARAMETERS MENU.

8.2.2.3 Controller - Traps/Relays Manager.

This frame let the user accede to SNMP traps management; for every possible alarm it allows to enable or disable the traps sending. Moreover, it is possible to set their destination address and configure a destination mail address (if supported by customer’s network).

Traps Management

Controller Traps

Trap	Enable/Disable
Voltage	<input type="checkbox"/>
PSU1	<input checked="" type="checkbox"/>
PSU2	<input type="checkbox"/>
FAN1	<input type="checkbox"/>
FAN2	<input type="checkbox"/>

Apply

FIGURE 28: WEB CONTROLLER FORM –TRAPS MANAGEMENT.

FIGURE 29: WEB CONTROLLER FORM – SNMP TRAPS RECEIVERS.

FIGURE 30: WEB CONTROLLER FORM – MAIL MANAGEMENT.

TABLE 6: MAIL MANAGEMENT

SMTP Server	Setting of SMTP server
Username	Setting of Username
Password	Setting of Password
From	Setting Source Name
To 1	Setting Destination address
To 2	Setting Destination address
CA Server certificate	Upload CA certificate for security

This information depends on customer’s network. If you have not this information, please contact your network administrator.

Alarm Rele 1 Configuration	
Rele	Enable/Disable
MS2_1 REFERENCE LOCK	<input type="checkbox"/>
MS2_1 ASI INPUT ALARM	<input type="checkbox"/>
MS2_1 MODULATION ALARM	<input type="checkbox"/>

Alarm Rele 2 Configuration

Alarm Rele 3 Configuration

Apply

FIGURE 31: WEB CONTROLLER FORM – RELAYS MANAGEMENT.

The controller board hosts 3 relays offering dry contacts normally open in the DB15 connector of the front panel (see 7.1.1 for the pinout) ; this form let the user configure the alarm that can be associated to each relay.

TABLE 7: RELAYS MANAGEMENT

MS2_i REFERENCE LOCK	Let the user enable/disable the alarm related to reference lock coming from MS2 board, "i" position (slot 1 in the example)
MS2_i ASI INPUT ALARM	Let the user enable/disable the alarm related to ASI input coming from MS2 board, "i" position (slot 1 in the example)
MS2_i MODULATION ALARM	Let the user enable/disable the alarm related to the modulator coming from MS2 board, "i" position (slot 1 in the example)

8.2.2.4 Controller - Tools.

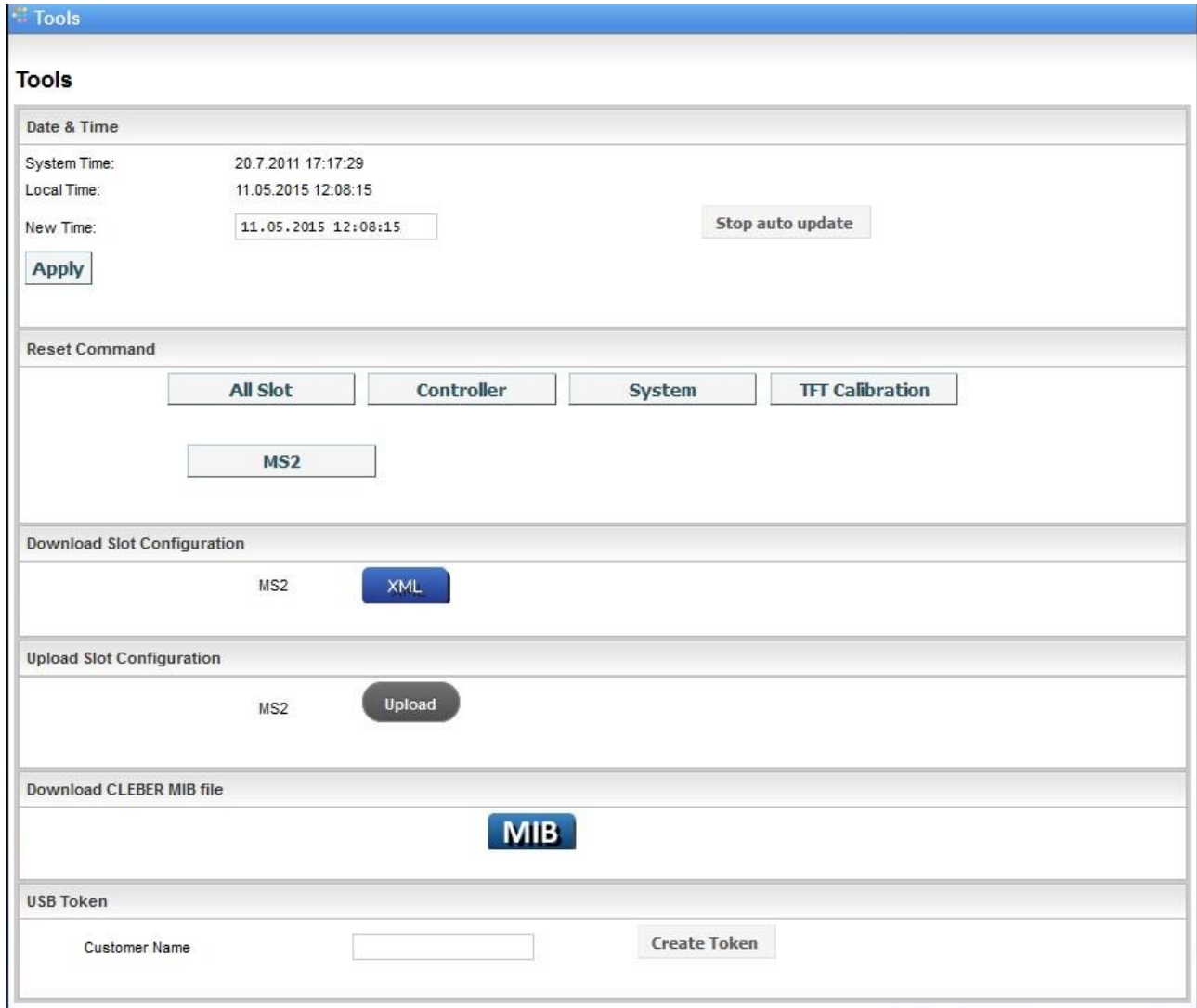

FIGURE 32: WEB CONTROLLER FORM – GENERAL INFO AND TOOLS.

TABLE 8: DATE AND TIME

System Time	It shows System Time
Local Time	It shows local time (if taken from NTP server)
New Time	Text box to modify local time.
Stop auto update	Button; let the user disable "auto-updating" of Local Time.

TABLE 9: RESET COMMAND

All Slot	Let the user reset all boards in the control unit
Controller	Let the user reset just the user-interface microprocessor
System	Let the user reset both microprocessor and optional boards
TFT Calibration	Let the user launch the TFT calibration procedure
MS2	Let the user reset MS2 board

TABLE 10: DOWNLOAD SLOT CONFIGURATION

MS2	Let the user save actual configuration for MS2 board
-----	--

TABLE 11: UPLOAD SLOT CONFIGURATION

MS2	Let the user upload a stored configuration for MS2 board
-----	--

TABLE 12: DOWNLOAD MIB FILE

Download CLEBER MIB file	By clicking on MIB icon  user can download the MIB file for the CLEBER
--------------------------	---

	platform.
--	-----------

TABLE 13: CREATE TOKEN

Customer Name	Indicate exact Customer Name (see 8.2.2.1); Token is generated on the basis of the Customer Name.
Create Token	Push this button to generate the Token file. Token is to be installed on a USB Pen-Drive and connected to front panel USB connector to grant read/write rights while using the TFT.

8.2.2.5 Controller - Password management.

FIGURE 33: WEB CONTROLLER FORM –PASSWORD MANAGEMENT.

This form let modify the passwords for web interface, TFT and the SNMP communities. Passwords should be composed of at least six characters and cannot overcome fifteen characters. The password level that can be modified is subject to the rights of the user. The user “User” cannot change passwords. User “Super-User” can change its own and the “User” ones. The “Administrator” can change any password.

8.2.3 Tab Slot.

The Tab “Slot” let the user monitor and configure every single board composing the system; user is asked to select the board he may want to check, like the number 2 in the example below.

FIGURE 34: WEB SLOT FORM – PLUG IN BOARD SELECTION.

See 9.3 **Errore. L'origine riferimento non è stata trovata.** for detailed description.

8.2.4 Tab Upgrade.

Web tab regarding upgrade is composed by 1 frame:

- Machine upgrade

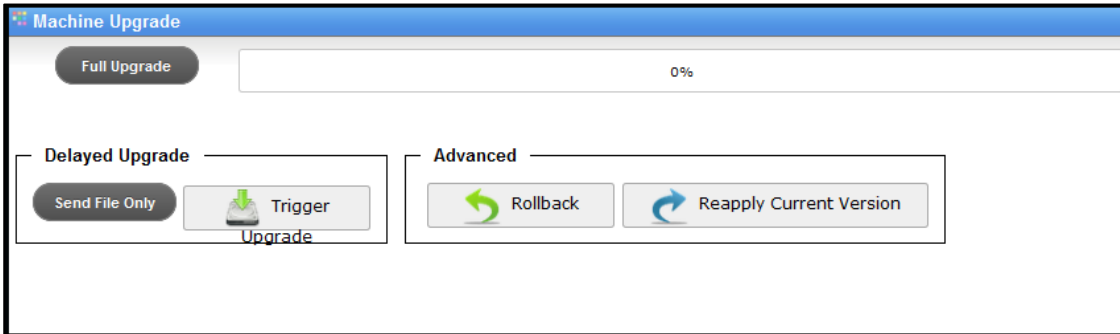

FIGURE 35: WEB UPGRADE FORM - FIRMWARE UPDATE.

Three upgrade modalities are possible:

1. Full upgrade
2. Delayed Upgrade
3. Advanced

Clicking on *Full Upgrade* button, user is asked to select the upgrade file, to be browsed in its personal device memory; choosing this modality, the upgrade will be performed immediately.

Clicking on *Send File Only* button, the user will just upload the file to internal flash, but can decide when to apply it clicking on *Trigger Upgrade*.

The Advanced menu let the user rollback to previous version or reapply the existing file, in case of suspicious malfunctioning.

8.2.5 Tab Log.

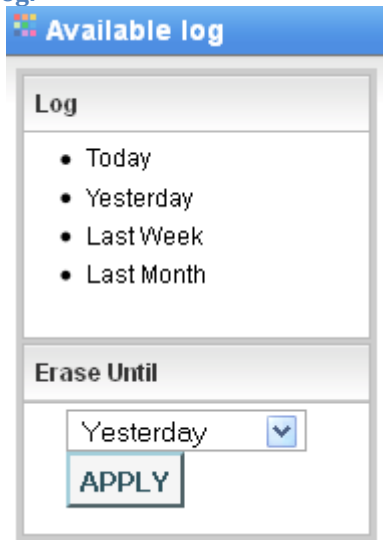

FIGURE 36 : WEB LOG FORM – AVAILABLE LOG.

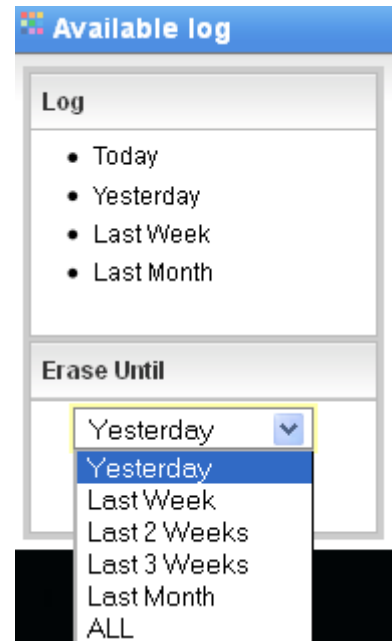

FIGURE 37: WEB LOG FORM – AVAILABLE LOG EXPANDED.

The equipment offers an operation log service that can be checked in this tab of the web interface.

In left part of the web page, the form concerning available logs is present, grouped by:

- Daily report
- Last day
- Last week
- Last month

In order to avoid huge memory usage, it is recommended to delete old records using **Erase until** form and selecting desired interval (Figure 37).

In central part of the page, log messages are reported, organized in a table that can be ordered, filtered and resized in terms of number of rows per page.

Records belong to 4 different categories are shown with different colours for user facility:

1. Messages
2. Configurations
3. Alarms
4. Warnings

Every record has a time, a description and an origin; an alarm event is described in appendix with OCCURRED tag, while the alarm condition recovery is a Message with appendix RECOVERED. Records can be ordered in every column and filtered.

Log can be saved with many different formats for further elaborations and storage; files formats available are:

- .xls
- .xml
- .csv
- .tsv
- .html
- .json

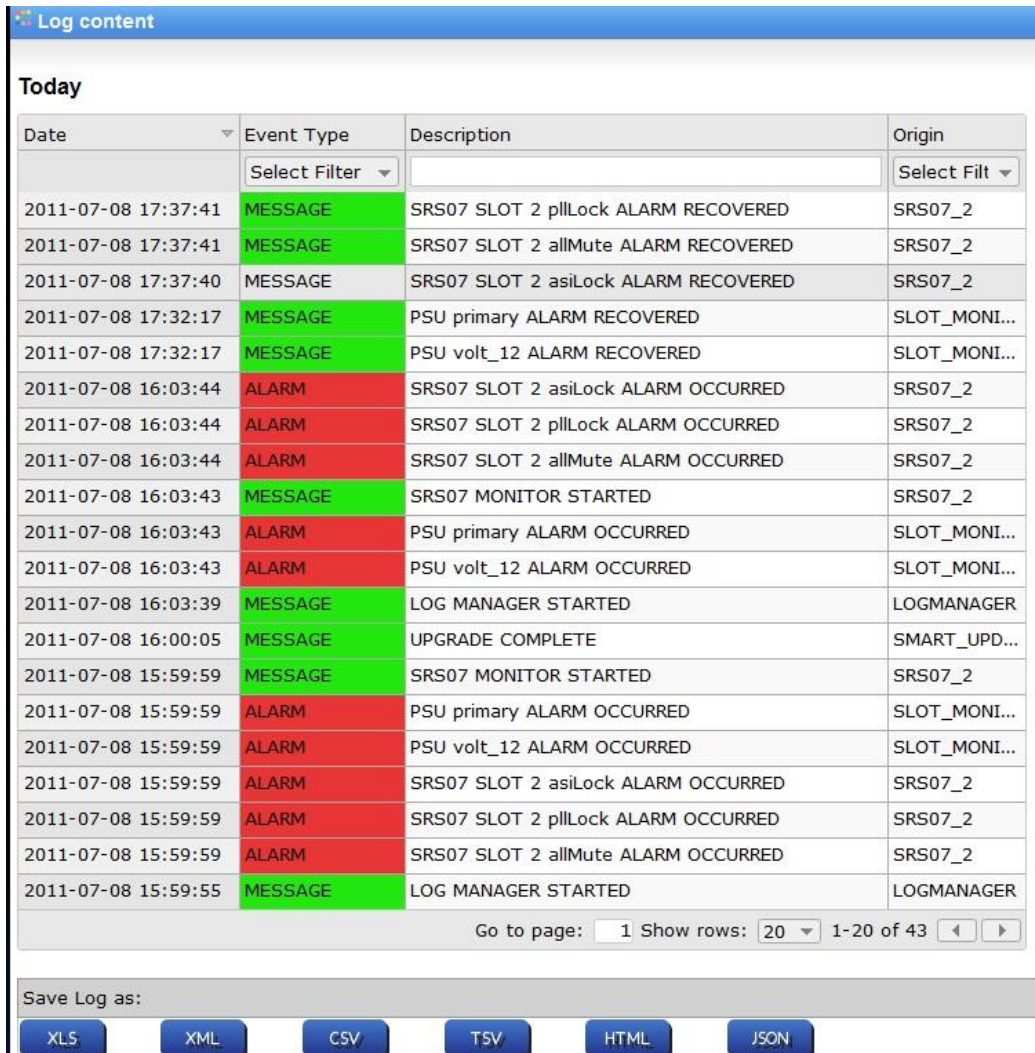

The screenshot shows a web interface titled "Log content" with a table of log entries. The table has four columns: Date, Event Type, Description, and Origin. The Event Type column uses color coding: green for MESSAGE, red for ALARM, and grey for other types. Below the table, there is a "Go to page" field set to 1, a "Show rows" dropdown set to 20, and a "1-20 of 43" indicator. At the bottom, there is a "Save Log as:" section with buttons for XLS, XML, CSV, TSV, HTML, and JSON.

Date	Event Type	Description	Origin
2011-07-08 17:37:41	MESSAGE	SRS07 SLOT 2 pllLock ALARM RECOVERED	SRS07_2
2011-07-08 17:37:41	MESSAGE	SRS07 SLOT 2 allMute ALARM RECOVERED	SRS07_2
2011-07-08 17:37:40	MESSAGE	SRS07 SLOT 2 asiLock ALARM RECOVERED	SRS07_2
2011-07-08 17:32:17	MESSAGE	PSU primary ALARM RECOVERED	SLOT_MONI...
2011-07-08 17:32:17	MESSAGE	PSU volt_12 ALARM RECOVERED	SLOT_MONI...
2011-07-08 16:03:44	ALARM	SRS07 SLOT 2 asiLock ALARM OCCURRED	SRS07_2
2011-07-08 16:03:44	ALARM	SRS07 SLOT 2 pllLock ALARM OCCURRED	SRS07_2
2011-07-08 16:03:44	ALARM	SRS07 SLOT 2 allMute ALARM OCCURRED	SRS07_2
2011-07-08 16:03:43	MESSAGE	SRS07 MONITOR STARTED	SRS07_2
2011-07-08 16:03:43	ALARM	PSU primary ALARM OCCURRED	SLOT_MONI...
2011-07-08 16:03:43	ALARM	PSU volt_12 ALARM OCCURRED	SLOT_MONI...
2011-07-08 16:03:39	MESSAGE	LOG MANAGER STARTED	LOGMANAGER
2011-07-08 16:00:05	MESSAGE	UPGRADE COMPLETE	SMART_UPD...
2011-07-08 15:59:59	MESSAGE	SRS07 MONITOR STARTED	SRS07_2
2011-07-08 15:59:59	ALARM	PSU primary ALARM OCCURRED	SLOT_MONI...
2011-07-08 15:59:59	ALARM	PSU volt_12 ALARM OCCURRED	SLOT_MONI...
2011-07-08 15:59:59	ALARM	SRS07 SLOT 2 asiLock ALARM OCCURRED	SRS07_2
2011-07-08 15:59:59	ALARM	SRS07 SLOT 2 pllLock ALARM OCCURRED	SRS07_2
2011-07-08 15:59:59	ALARM	SRS07 SLOT 2 allMute ALARM OCCURRED	SRS07_2
2011-07-08 15:59:55	MESSAGE	LOG MANAGER STARTED	LOGMANAGER

FIGURE 38: WEB LOG FORM – LOG.

8.2.6 Tab Statistic.

The equipment UI offers a software engine to record measurements and gives some statistical analysis to the user, with the possibility to export collected data in different file formats such as XLS and XML.

User is asked to select the variable in the tile menu, shown in Figure 39, user can choose between following measurements:

- 1) Temperature
- 2) ASI 1 bitrate
- 3) ASI 2 bitrate
- 4) ASI BUS 1 bitrate
- 5) ASI BUS 2 bitrate
- 6) ACM ASI bitrate
- 7) SINGLE ASI bitrate
- 8) DVB-ASI bitrate

After measurements selection, the chart shows the instantaneous values and the statistical data over a period that can be adjusted using the red bar below the chart.

Values available are:

- 1) Instantaneous value
- 2) Mean value
- 3) Mean value over 15 minutes
- 4) Mean value over 24 hours
- 5) Minimum value
- 6) Maximum value.

All data are reported in the table below the red bar and can also be exported in following formats for offline analysis:

- 1) XLS
- 2) XML
- 3) CSV
- 4) TSV
- 5) HTML
- 6) JSON

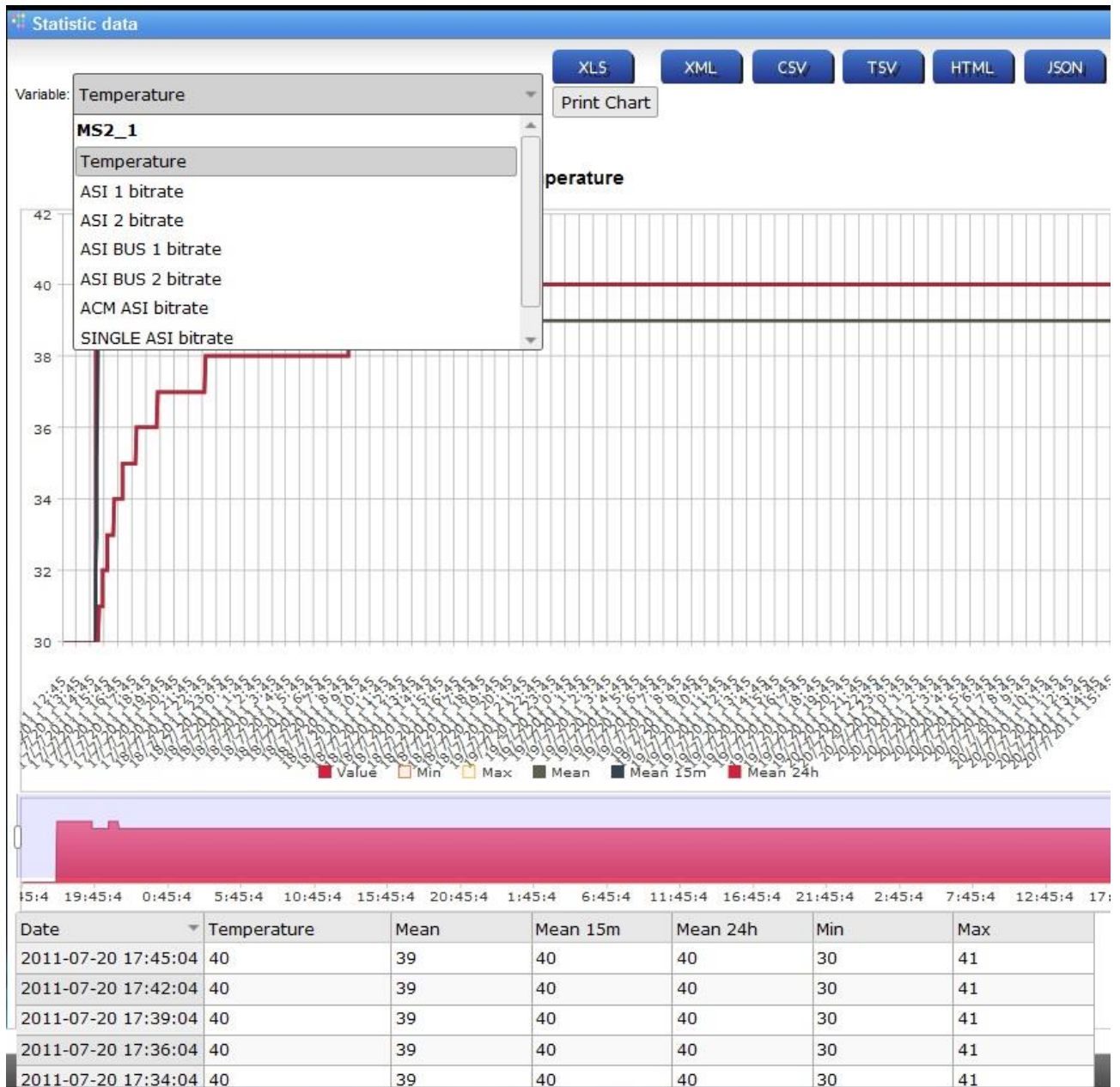

FIGURE 39: WEB STATISTIC FORM.

9 MS2.

MS2 is the code identifying the multi-standard modulator board, able to transmit either in DVB-T, DVB-S and DVB-S2 modalities. In DVB-S2 it can manage up to 8 Input Stream Identifiers (ISI), receiving 2 from back panel connectors and 6 from internal bus after multiplexing or aggregation. It can be installed in any position of CLEBER chassis RK610 and occupies one basic slot (6 available).

The board provides two upconverter with direct synthesis through two independent DACs; one covers the full L-Band spectrum between 950 and 2150 MHz and the others is for IF output (synthesizable between 50 and 180 MHz)



FIGURE 40: MS2 BOARD PICTURE

9.1 Technical Specifications MS2.

TABLE 14: MS2 TECHNICAL SPECIFICATIONS

GENERAL	
Standard:	ETSI EN 300 421 (DVB-S) ETSI EN 302 307 (DVB-S2)
DVB-S	<ul style="list-style-type: none"> • Outer FEC: Reed Solomon • Inner FEC: Viterbi • MODCODs: <ul style="list-style-type: none"> QPSK: 1/2, 2/3, 3/4, 5/6, 7/8 8PSK: 2/3, 5/6, 8/9
DVB-S2:	<ul style="list-style-type: none"> • Outer FEC: BCH • Inner FEC: LDPC

	<ul style="list-style-type: none"> • MODCODS: QPSK: 1/4, 1/3, 2/5, 1/2, 3/5, 2/3, 3/4, 4/5,5/6, 8/9, 9/10 8PSK: 3/5, 2/3, 3/4, 5/6, 8/9, 9/10 16APSK: 2/3, 3/4, 4/5, 5/6, 8/9, 9/10 32APSK: 3/4, 4/5, 5/6, 8/9, 9/10
Symbol Rate Range:	0,05 – 49,5 Mbaud
Frame length:	DVB-S: 188 bytes DVB-S2: Short Frames 16200 bits Normal Frames 64800 bits
Roll-off factor:	0,05-0,10-0,15-0,20-0,25-0,30-0,35
INPUT INTERFACES	
Back panel:	2 ASI inputs on BNC (F) - 75 ohms
Internal Bus:	2 balanced ASI lines (option, another board required such as RMXx4, DMXx4, ADx4, ASx4, EHD, ...)
ASI Format:	188 and/or 204 byte mode
ASI Multistream interface:	<ul style="list-style-type: none"> • Up to 8 ISI • Rate adapter
OUTPUT INTERFACES	
<i>L-band output:</i>	
Connector:	F (F), 50 ohms or SMA (F). 50 ohms
Return loss:	> 14dB
Level:	-40/+8dBm (\pm 2dB)
Frequency:	950 - 2150 MHz (10 Hz steps)
Spurious:	Better than -65dBc/4 kHz @ +5dBm
Phase Noise with Internal Reference (typical dBc/Hz@950-2150):	10 Hz -60 100Hz -78 1kHz -103 10kHz -110 100kHz -112 1MHz -133
<i>L-band monitoring output:</i>	
Connector:	SMA (F), 50 ohms
Return loss:	> 14dB
Level:	-45dBm
Frequency:	Same as per L-band output.
<i>IF-band:</i>	
Connector:	BNC (F), 75 ohms
Return loss:	> 20dB
Level:	-40/+10dBm (\pm 3dB)
Frequency:	50 - 180 MHz (10 Hz steps)
Spurious:	Better than -65dBc/4 kHz @ +5dBm
Phase Noise with Internal Reference (typical dBc/Hz@50-140):	10 Hz -65 100Hz -80 1kHz -105 10kHz -114 100kHz -120 1MHz -133
10 MHz reference input / output interface:	
<i>Input:</i>	
Connector:	BNC (F) , 50 ohms
Level:	-8dBm ÷ +5dBm
Autosensing:	Available
<i>Output:</i>	
Connector:	BNC (F) , 50 ohms
Level:	0dBm \pm 1dB
<i>Internal Reference:</i>	

Stability:	High: ± 1 ppm over -20°C to 70°C Very High: ± 5 ppb over 0°C to 65°C
Ageing:	High: ± 1 ppm/year Very High: ± 1 ppb/day ± 50 ppb/ 10 year
Electrical	
Power Consumption:	18W

9.2 TFT.

Through this page, user can manage MS2 plug-in board, the modulator.

Basically, the modulator board can generate digital modulated signals according to three different ETSI standards that are:

- 1) DVB-S
- 2) DVB-S2
- 3) DVB-T

Active areas:

- Directional arrow “UP”  to go back to main menu.

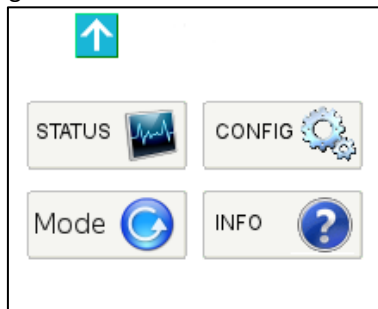





FIGURE 29: MS2 GENERAL MENU.

- Directional arrow “UP”  to go back to main menu.

-  To go to Menu Status – DVB-S2. or Menu Status – DVB-T.

-  to go to Menu Config - General.

-  to go to 9.2.10

-  to go to Modulator Info Menu

9.2.1 Menu Status – DVB-S2.

This menu is shown only if selected transmission standard is DVB-S2.

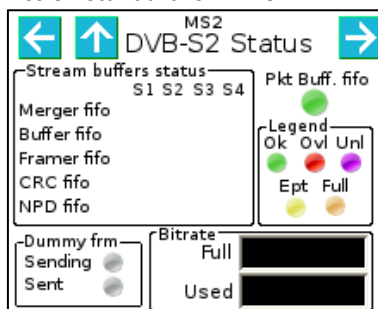

FIGURE 30: MS2 STATUS DVBS-2 MENU.

Active areas:

- Directional arrow “UP”  to go back to main menu.

- Directional arrows “LEFT” ← and “RIGHT” → to browse modulator menu (Go to ASI Status Menu, see 9.2.4).

Much information has been grouped in the same page for an exhaustive view of DVB-S2 status.

Three major areas can be found, described in the following lines:

- 1) Stream buffer status
- 2) Dummy Frame
- 3) Bitrate

Since much FIFO information is shown in graphic format, a legend is provided to facilitate the interpretation; hereunder user can find the explanation of Legend colours.



FIGURE 31: LEGEND FOR FIFO STATUS.

TABLE 15: MS2 INPUT FIFO STATUS

Colour	Tag	Description
Green	Ok	Status normal
Red	Ovl	Fifo Overrun (warning condition -> possible data loss)
Violet	Unl	Fifo Underrun (warning condition -> possible data loss)
Yellow	Ept	Fifo Empty (alarm condition -> data loss)
Orange	Full	Fifo Full (alarm condition -> data loss)

General FIFO information is *Pkt. Buff. FIFO* which refers to the whole baseband frame.

In Multi-Stream configuration, processing of each input stream involves input stream synchronization (ISSY), null packet deletion (NPD) and CRC-8 encoding. These input streams are then buffered and selectively combined into BBFRAMEs for encoding and transmission.

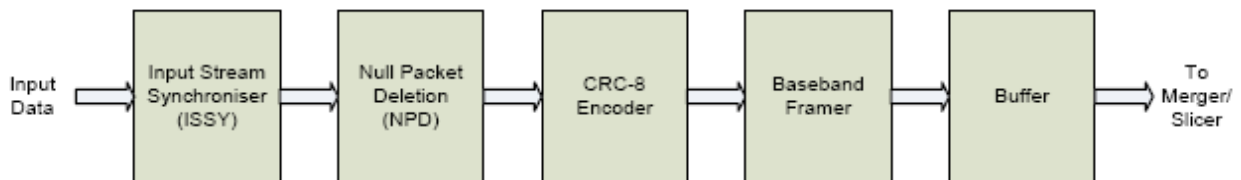

FIGURE 41: INPUT STREAM PROCESSING FOR ONE STREAM OF THE MULTI-STREAM INTERFACE.

A FIFO controls every stage of this process, so, as MS2 accepts 4 input streams in DVB-S2 multistream modality, a table is provided where columns are referred to streams (S1 to S4) and rows to the FIFOs.

Stream buffers status				
	S1	S2	S3	S4
Merger fifo				
Buffer fifo				
Framer fifo				
CRC fifo				
NPD fifo				

FIGURE 42: STREAM BUFFER STATUS TABLE.

Two more information is supplied as described hereunder.

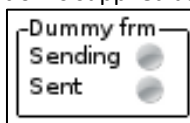

FIGURE 43: DUMMY FRAME CHECK.

In this area, customer can check if modulator is sending dummy frames or if some of them have been sent since last reading.

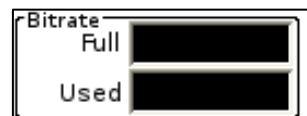

FIGURE 44: BITRATE CHECK.

In this area, customer can check the Used and the maximum available bitrate with actual modulator settings.

9.2.2 Menu Status – DVB-S.

This menu is shown only if selected transmission standard is DVB-S.

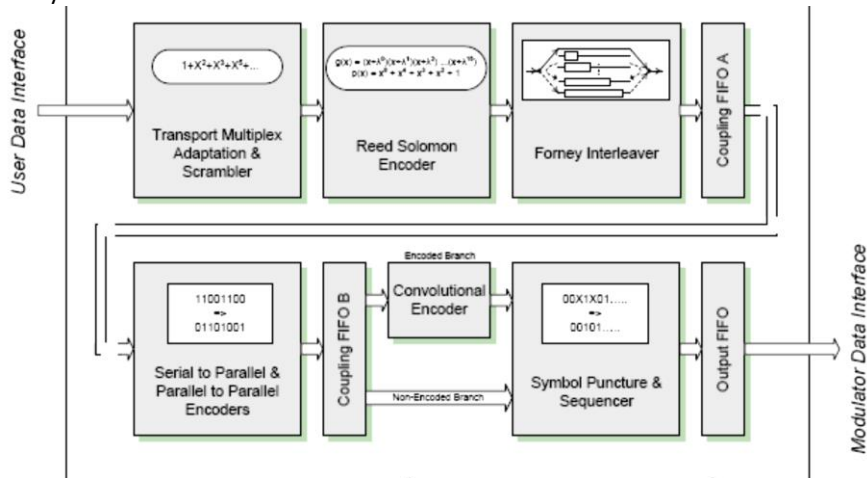

FIGURE 45: DVB-S DSNG FEC ENCODER CORE STRUCTURE.

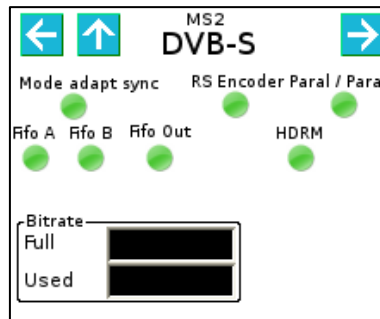

FIGURE 46: MS2 STATUS DVB-S

TABLE 16: MS2 DVB-S STATUS PARAMETERS MENU

Tag	Description
Mode adapt sync	Mode Adaptation Synchronized (see Figure 45)
RS Encoder	Reed Solomon Encoder Status (see Figure 45)
Paral/Paral	Serial to Parallel & Parallel to Parallel Encoder Status (see Figure 45)
FIFO A	FIFO A Status (see Figure 45)
FIFO B	FIFO B Status (see Figure 45)
FIFO Out	FIFO OUT Status (see Figure 45)
HDRM	Modulator circuit status (see Figure 45)

Active areas:

- Directional arrow “UP” to go back to main menu.
- Directional arrows “LEFT” and “RIGHT” to browse modulator menu (Go to ASI Status Menu, see 9.2.4).

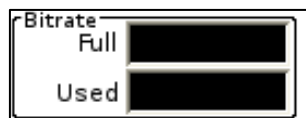

FIGURE 47: BITRATE CHECK.

In this area, customer can check the Used and the maximum available bitrate with current modulator settings.

9.2.3 Menu Status – DVB-T.

This menu is shown only if actual transmission standard is DVB-T.

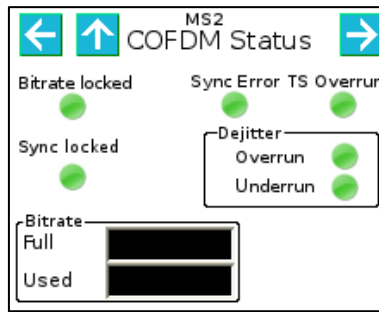

FIGURE 48: MS2 STATUS DVB-T.

Active areas:

- Directional arrow “UP” to go back to main menu.
- Directional arrows “LEFT” and “RIGHT” to browse modulator menu (Go to ASI Status Menu, see 9.2.4).

TABLE 17: MS2 DVB-T STATUS PARAMETERS MENU

Tag	Description
Bitrate locked	Data lock indication.
Sync Error	Input stream Sync byte error indication.
TS Overrun	Input TS bitrate is too high for actual modulator settings.
Sync Locked	Sync lock indication.
Dejitter Overrun	Dejittering circuit is working at a high level of its FIFO; this condition may lead to data loss and/or jitter problems.
Dejitter Underrun	Dejittering circuit is working at a low level of its FIFO; this condition may lead to data loss and/or jitter problems.

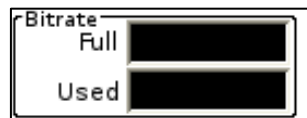

FIGURE 49: BITRATE CHECK.

In this area, customer can check the Used and the maximum available bitrate with actual modulator settings.

9.2.4 Menu Status – ASI.

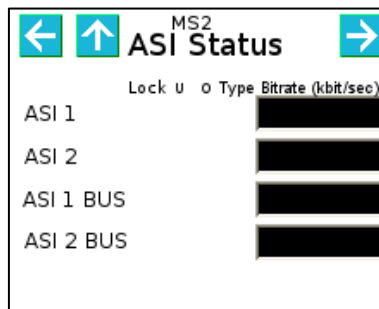

FIGURE 50: MS2 STATUS ASI.

Active areas:

- Directional arrow “UP” to go back to main menu.
- Directional arrows “LEFT” and “RIGHT” to browse modulator menu

This menu is available for any type of transmission mode adopted (DVB-S/S2 or DVB-T) and reports status of each ASI stream at MS2 input.

ASI 1 and ASI 2 come from back panel (see Figure 64); ASI BUS 1 and ASI BUS 2 come from internal bus (generally from encoder board).

For every stream, following information is shown:

TABLE 18: MS2 DVB-S2 INPUTS STATUS PARAMETERS MENU

Tag	Type	Description
Lock	Led icon	Input stream is present and interface is locked.
U	Led icon	Input stream FIFO is currently underrun (almost empty)
O	Led icon	Input stream FIFO is currently overrun (almost full)
Type	Image :	Input stream format (188 or 204 frame length)

Bitrate (Kbit/sec)	Text box	Measured bitrate in Kbit/sec
--------------------	----------	------------------------------

9.2.5 Menu Config - General.

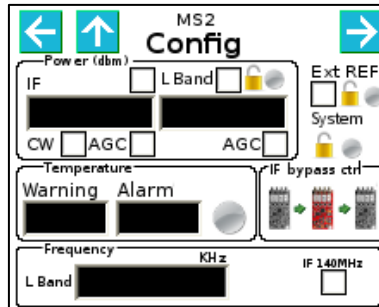

FIGURE 51: MS2 CONFIG MODULATOR

Active areas:







- Directional arrow “UP”  to go back to main menu.
- Directional arrows “LEFT”  and “RIGHT”  to browse modulator config menu
- Other areas described in Table 19

TABLE 19: MS2 CONFIG PARAMETERS MENU

Tag	Type	Action
IF 70 MHz	Text box	Let the user modify IF level between -20 ÷ +5dBm through virtual keyboard.
IF 70 MHz	<input checked="" type="checkbox"/> <input type="checkbox"/> Checkbox	Let the user enable/disable IF output available on back panel.
L Band	Text box	Let the user modify L-Band level between -40 ÷ +8dBm through virtual keyboard.
L Band	<input checked="" type="checkbox"/> <input type="checkbox"/> Checkbox	Let the user enable/disable L-Band output available on back panel.
CW	<input checked="" type="checkbox"/> <input type="checkbox"/> Checkbox	Let the user enable/disable Continuous Wave (Clean Carrier) generation
En agc	<input checked="" type="checkbox"/> <input type="checkbox"/> Checkbox	Let the user enable/disable the Automatic Gain Control function on IF output.
Ext Ref	<input checked="" type="checkbox"/> <input type="checkbox"/> Checkbox	Let the user enable/disable the 10 MHz External Reference
Temperature Warning	Text box	Let the user modify the warning temperature threshold [°C]
Temperature Alarm	Text box	Let the user modify the alarm temperature threshold [°C]
IF bypass ctrl	Image	Let the user configure the IF path in the internal bus.  IF path is bypassed by MS2 board.  IF is generated by MS2 and forwarded to the board at the right  IF path is interrupted by MS2 board.
EXT Ref		10 MHz VCXO Locking status
Temperature		Temperature status according to reading and threshold configured
System		System PLL Locking status
L-Band Frequency	Text box	Let the user modify the frequency of operation for L-Band output between 950 and 2150 MHz
IF 140	Checkbox	Let the user set directly the IF frequency as 140 MHz

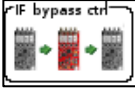
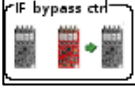
9.2.6 Menu Config – DVB-S2.

This menu is shown only if selected transmission standard is DVB-S2.

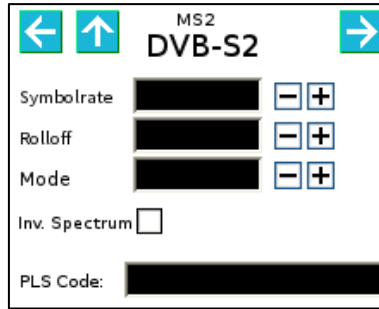

FIGURE 52: MS2 CONFIG DVB-S2

Active areas:

- Directional arrow “UP” to go back to main menu.
- Directional arrows “LEFT” and “RIGHT” to browse modulator config menu.
- Other areas described in Table 20

TABLE 20: MS2 DVB-S2 CONFIG PARAMETERS MENU

Tag	Type	Action
Symbol Rate	Text box	Let the user set the modulator symbol rate, in Kbaud/s Max value is 49.5 Mbaud.
Rolloff	virtual buttons	Selection between following values: <ul style="list-style-type: none"> • 0,05 • 0,10 • 0,15 • 0,20 • 0,25 • 0,30
Mode	virtual buttons	Selection between single SINGLE and multi- MULTI -stream modality.
Inv. Spectrum	<input checked="" type="checkbox"/> <input type="checkbox"/> Checkbox	Let the user enable/disable the spectrum inversion.
PLS Code	Text box	Let the user configure the PLS code adopted.

9.2.7 Menu Config – DVB-S2 ASI.

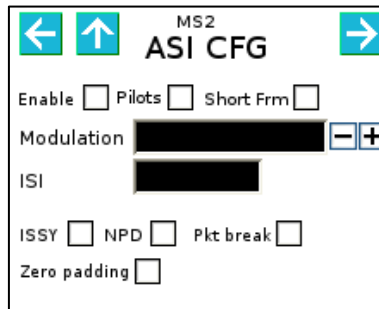

FIGURE 44: MS2 CONFIG DVB-S2 ASI

Depending on DVB-S2 mode selected in previous menu, one (in case of single-stream) or four (in case of multi-stream) ASI CFG menu are shown.

- ASI CFG 1 refers to ASI 1 BNC connector on back panel.
- ASI CFG 2 refers to ASI 2 BCN connector on back panel.
- ASI CFG 3 refers to ASI BUS 1.
- ASI CFG 4 refers to ASI BUS 2.

For each stream, following parameters can be managed, as shown in Table 21.

TABLE 21: MS2 DVB-S2 INPUTS PARAMETERS MENU

Tag	Type	Action
Enable	<input checked="" type="checkbox"/> <input type="checkbox"/> Checkbox	Let the user enable the related input stream.
Pilots	<input checked="" type="checkbox"/> <input type="checkbox"/> Checkbox	Let the user enable the Pilot carriers’ transmission.
Short Frm	<input checked="" type="checkbox"/> <input type="checkbox"/> Checkbox	Let the user enable “Short Frame” transmission mode.
Modulation	virtual buttons	Let the user select the constellation between QPSK, 8PSK, 16APSK, 32 APSK.
ISI	Text box.	Let the user configure the Input Stream Identifier.
ISSY	<input checked="" type="checkbox"/> <input type="checkbox"/> Checkbox	Let the user enable/disable ISSY (Input Stream SYNchronizer).
NPD	<input checked="" type="checkbox"/> <input type="checkbox"/> Checkbox	Let the user enable/disable NPD function (Null Packet Deletion)

Pkt break	<input checked="" type="checkbox"/> <input type="checkbox"/> Checkbox	Let the user enable/disable "Packet break" function.
Zero padding	<input checked="" type="checkbox"/> <input type="checkbox"/> Checkbox	Let the user enable/disable the "Zero Padding" function

9.2.8 Menu Config – DVB-S.

This menu is shown only if selected transmission standard is DVB-S.

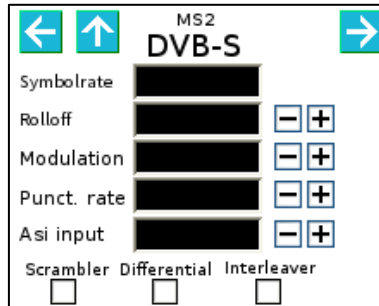

FIGURE 45: MS2 CONFIG DVB-S

Active areas:







- Directional arrow "UP"  to go back to main menu.
- Directional arrows "LEFT"  and "RIGHT"  to browse modulator menu.
- Other areas described in Table 22

TABLE 22: MS2 DVB-S PARAMETERS MENU

Tag	Type	Action
Symbol Rate	Text box	Setting of modulator symbol rate, in Kbaud/s.
Rolloff	 virtual buttons	Selection between following values: <ul style="list-style-type: none"> • 0,20 • 0,25 • 0,30
Modulation	 virtual buttons	Selection between following values: <ul style="list-style-type: none"> • QPSK • 8PSK • 16QAM
Punct. Rate	 virtual buttons	Selection between following values: <ul style="list-style-type: none"> • 1/2 • 2/3 • 3/4 • 5/6 • 7/8 • 8/9
Asi input	 virtual buttons	Selection between possible inputs: <ol style="list-style-type: none"> 1) ASI 1 2) ASI 2 3) ASI BUS 1 4) ASI BUS 2
Scrambler	<input checked="" type="checkbox"/> <input type="checkbox"/> Checkbox	Data scrambler enabling/disabling
Differential	<input checked="" type="checkbox"/> <input type="checkbox"/> Checkbox	Differential encoder enabling/disabling
Interleaver	<input checked="" type="checkbox"/> <input type="checkbox"/> Checkbox	Data interleaver enabling/disabling

9.2.9 Menu Config – DVB-T.

This menu is shown only if selected transmission standard is DVB-T.

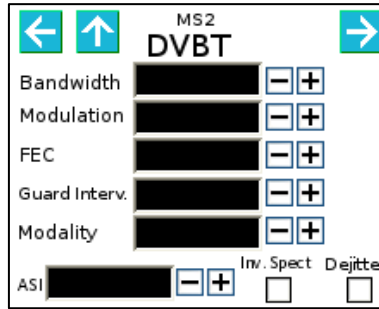

FIGURE 46: MS2 CONFIG DVBT.

Active areas:

- Directional arrow “UP” to go back to main menu.
- Directional arrows “LEFT” and “RIGHT” to browse modulator menu.
 - Other areas described in Table 23

TABLE 23: MS2 DVBT PARAMETERS MENU

Tag	Type	Action
Bandwidth	virtual buttons	Let the user set the signal bandwidth (6/7/8 MHz)
Modulation	virtual buttons	Let the user set the constellation (QPSK/16QAM/64QAM)
FEC	virtual buttons	Let the user set the FEC rate (1/2, 2/3, 3/4, 5/6, 6/7, 7/8)
Guard Interv.	virtual buttons	Let the user set the guard interval of COFDM signal (1/2, 1/4, 1/8, 1/16, 1/32)
Modality	virtual buttons	Let the user set the number of carriers of COFDM signal (2k/8k)
ASI	virtual buttons	Let the user select the ASI source (ASI 1, ASI 2, ASI BUS 1, ASI BUS 2)
Inv. Spect	<input checked="" type="checkbox"/> <input type="checkbox"/> Checkbox	Let the user enable/disable the spectrum inversion
Dejitter	<input checked="" type="checkbox"/> <input type="checkbox"/> Checkbox	Let the user enable/disable the dejittering function.

9.2.10 Menu Mode Selection.

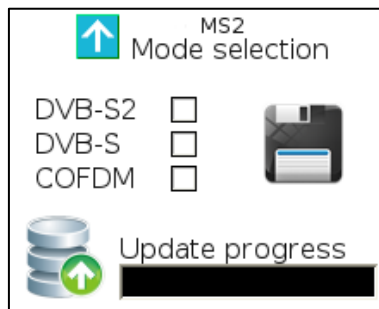

FIGURE 47: MS2 MODE MENU.

Through this menu, user can change transmission standard by pressing on the related checkbox (of course, one at a time can be selected); when transmission standard is changed to or from COFDM, a full upgrade of the modulator is performed (Update status can be checked in the “Update progress bar”); when standard is changed between DVB-S and DVB-S2, it will take just a few seconds while user should wait for page update.

Active areas:

- Directional arrow “UP” to go back to main menu.
- Checkbox for standard selection.
-

9.2.11 Menu Info.

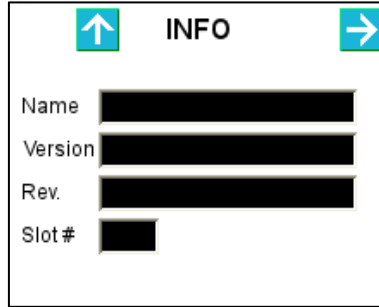

FIGURE 48: MS2 INFO MENU.

Active areas:



- Directional arrow “UP”  to go back to main menu.
- Directional arrow “RIGHT”  to browse modulator info menu.

TABLE 24: MS2 INFO MENU

Tag	Type	Description
Name	Text Box	Indication of the name of the board.
Version	Text Box	Indication of software version for on-board microcontroller.
Rev.	Text Box	Indication of software version revision for on-board microcontroller
Slot#	Text Box	Indication of slot number.

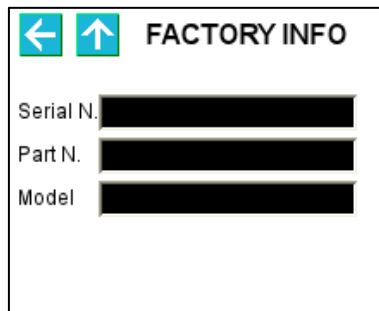

FIGURE 49: MS2 FACTORY INFO MENU.

Active areas:



- Directional arrow “UP”  to go back to main menu.
- Directional arrow “LEFT”  to browse modulator info menu.

TABLE 25: MS2 FACTORY INFO MENU

Tag	Type	Description
Serial N.	Text Box	Indication of Serial Number of the board.
Part N.	Text Box	Indication of Part Number of the board.
Model	Text Box	Indication of Model of the board.

9.3 Web Interface.



FIGURE 53: WEB SLOT FORM - MS2 GENERAL INFO.

TABLE 26: MS2 GENERAL INFO

Tag	Description
Name	Board Name
Version	Firmware version
Revision	Firmware version revision
FPGA	FPGA firmware name
FW Version	FPGA firmware version
FW Revision	FPGA firmware revision
Serial Number	As per name
Part Number	As per name
Model	As per name



FIGURE 54: WEB SLOT FORM - MS2 GENERAL STATUS.

TABLE 27: MS2 STATUS PARAMETERS

Tag	Description
ASI Lock 1-2-3-4	Led indication for ASI inputs locking status; ASI 1-2 are BNC connectors; ASI 3-4 come from internal BUS
Temperature	Temperature measurement in °C (green if ok)
IF Power	IF level indication in dBm.
IF Frequency	IF frequency in KHz.
L-Band Power	L-Band power indication in dBm.
L-Band Frequency	L-Band frequency in KHz.



FIGURE 55: WEB SLOT FORM - MS2 OPERATIONAL MODE SETTING.

TABLE 28: MS2 OPERATIONAL MODE PARAMETERS.

Tag	Description
Standard	Let the user select the modulation standard between COFDM/DVB-T, DVB-S and DVB-S2. The button Change mode applies the choice and the related firmware is loaded into the FPGA of MS2 module.



FIGURE 56: WEB SLOT FORM - MS2 PRESET SETTINGS.

The menu let the user select stored configurations, to be recalled.

9.3.1 DVB-T version.



FIGURE 57: WEB SLOT FORM - MS2 STATUS (DVB-T).

TABLE 29: COFDM MODULATOR STATUS PARAMETERS MENU.

Tag	Description
Modulation	Modulation scheme (QPSK-16-64QAM)
Bandwidth	Signal bandwidth (6/7/8 MHz)
FEC Rate	Code rate
Guard Interval	Guard Interval(1/4, 1/8/, 1/16, 1/32)
Mode	Number of carriers (2K/8K)
Spectrum	Normal or Inverted
Dejitter	Dejittering algorithm enabling indication
ASI 1	Bitrate ASI 1 (selected one)
ASI 1 Lock	Lock indication (green if ok, red if not)
Bitrate locked	Bitrate lock indication (green if ok, red if not)
Sync Status	Sync status indication (green if ok, red if not)
Sync Error	Sync error signalling (green if ok, red if not)
TS Overrun	TS bitrate higher than capacity (green if ok, red if not)
Dejitter Overrun	Dejitter Fifo overrun indicator (green if ok, red if not)
Dejitter Underrun	Dejitter Fifo Underrun indicator (green if ok, red if not)

FIGURE 58: WEB SLOT FORM - MS2 CONFIG (DVB-T).

TABLE 30: MS2 CONFIG (DVB-T) PARAMETERS

Tag	Description
Warning Temperature Threshold	Let the user set Warning temperature threshold in °C
Alarm Temperature Threshold	Let the user set Alarm temperature threshold in °C
IF loop control	IF signals are forwarded through internal bus, in loop from left to right if seen from back panel. This field let the user set the IF loop control; options: <ul style="list-style-type: none"> Local to Next (forward the IF locally generated to the right) Previous to Next (forward the IF received from left to right) Drop (open the loop)
Reference (10MHz)	Let the user set the 10 MHz source between internal and external (fed through BNC connector, see Figure 64)
IF Frequency	Let the user set the IF frequency in KHz. Standard 70000 KHz.
LBand Power	L Band Power setting in dBm. Checkbox related for Enabling the transmission and AGC.
IF Power	If Power setting in dBm. Checkbox related for Enabling the transmission and AGC.
Bandwidth	6-7-8 MHz
Modulation	QPSK, 16QAM, 64QAM
FEC Rate	1/2, 2/3, 3/4, 5/6, 7/8
Guard interval	1/4, 1/8, 1/16, 1/32
Mode	Number of carriers (2K, 8K)
Spectrum	Normal, Inverted
Dejitte	Enable, Disable
ASI port	Input selection (just one at a time) <ul style="list-style-type: none"> ASI 1 ASI 2 ASI BUS 1 ASI BUS 2

9.3.2 DVB-S/S2 version.

DVB-S2	
Adaptation Buffer FIFO	EMPTY
Sending PL Dummy frame	NO
Sent PL Dummy frame	YES
ASI 1	24.6957 Mbps
ASI 1 Lock	Locked
MODCODE 1	QPSK 5/6
CRC fifo buffer	OK
Framer fifo buffer	EMPTY
Buffer fifo buffer	OK
Merger fifo slicer	OK

FIGURE 59: WEB SLOT FORM - MS2 STATUS (DVB-S2).

TABLE 31: MS2 INPUT FIFO AND MODULATOR PARAMETERS

Tag	Description
Adaptation Buffer FIFO	Buffer FIFO level indication (green if EMPTY)
Sending PL Dummy Frame	As per name
Sent PL Dummy Frame	As per name
ASI 1	ASI 1 bitrate indication in Mbps
ASI 1 Lock	ASI 1 locking indication (green if locked)
MODCODE 1	Modulation and FEC selected
CRC FIFO buffer	CRC buffer level indication
Framer FIFO buffer	Framer buffer level indication
Buffer FIFO buffer	Buffer level indication
Merger FIFO slicer	Merger status indication

DVB-S2

Symbol Rate:

Mode:

Stuffing:

Rolloff:

Spectrum:

PLS code:

FIGURE 60: WEB SLOT FORM - MS2 CONFIG (DVB-S2).

TABLE 32: MS2 CONFIG DVB-S2 PARAMETERS - 1

Tag	Description
Symbol Rate	Let the user set the modulator Symbol Rate in kbaud
Mode	Let the user set the modulation mode between: <ul style="list-style-type: none"> • Multistream • Single Stream • ACM Single Stream
Stuffing	Let the user set stuffing criteria between: <ul style="list-style-type: none"> • BBFrame stuffing • No Processing • TS null packet adapter
Rolloff	Let the user set the roll-off factor of modulator shaping filter (5-10-15-20-25-30-35%)
Spectrum	Let the user set the signal spectrum generation (Direct/Inverted)
PLS Code	Let the user set the Physical Layer Scrambling Code between 0 and 252140

FIGURE 61: WEB SLOT FORM - MS2 CONFIG (INPUTS SETTING, MULTISTREAM).

TABLE 33: MS2 CONFIG DVB-S2 PARAMETERS-2

Tag	Description
Enable	Let the user enable the related input
ISI	Let the user set the ISI (Input Stream Identifier) for Multistream operation
Modulation	Let the user select the desired MODCOD (modulation and FEC rate) QPSK 1/4, 1/3, 2/5, 1/2, 3/5, 2/3, 3/4, 4/5, 5/6, 8/9, 9/10 8PSK 3/5, 2/3, 3/4, 4/5, 5/6, 8/9, 9/10 16APSK 2/3, 3/4, 4/5, 5/6, 8/9, 9/10 32APSK 3/4, 4/5, 5/6, 8/9, 9/10
Frame type	Let the user change the Frame type (Normal/Short Frames)
Pilots	Let the user enable the pilot carriers transmission
NPD	Let the user enable
ISSY	Let the user enable the ISSY (Input Stream SYNchronizer)
Zero padding	Let the user enable ZERO PADDING function
Packet breaking	Let the user enable PACKET BREAKING function

FIGURE 62: WEB SLOT FORM - MS2 CONFIG (INPUTS SETTING, SINGLE STREAM OR ACM).

TABLE 34: MS2 CONFIG (INPUTS SETTING, SINGLE STREAM OR ACM) PARAMETERS

Tag	Description
ASI	Let the user select the source between ASI 1, ASI 2, ASI BUS 1 and ASI BUS 2
ISI	Let the user set the ISI (Input Stream Identifier) for Multistream operation
Modulation	Let the user select the desired MODCOD (modulation and FEC rate) QPSK 1/4, 1/3, 2/5, 1/2, 3/5, 2/3, 3/4, 4/5, 5/6, 8/9, 9/10 8PSK 3/5, 2/3, 3/4, 4/5, 5/6, 8/9, 9/10 16APSK 2/3, 3/4, 4/5, 5/6, 8/9, 9/10 32APSK 3/4, 4/5, 5/6, 8/9, 9/10
Frame type	Let the user change the Frame type (Normal/Short Frames)
Pilots	Let the user enable the pilot carriers transmission
NPD	Let the user enable
ISSY	Let the user enable the ISSY (Input Stream SYNchronizer)
Zero padding	Let the user enable ZERO PADDING function
Packet breaking	Let the user enable PACKET BREAKING function

9.3.3 DVB-S version.

DVB-S

Symbol rate: Kbps Rolloff:

Modulation: Puncture rate:

Scrambler: EN

Interleaver: EN

Asi port:

FIGURE 63: WEB SLOT FORM - MS2 CONFIG (DVB-S).

TABLE 35: MS2 CONFIG (DVB-S) PARAMETERS

Tag	Description
Symbol Rate	Let the user set the modulator Symbol Rate in kBaud
Rolloff	Let the user set the roll-off factor of modulator shaping filter (20%, 30%, and 35%)
Modulation	QPSK
Puncture Rate	1/2, 2/3, 3/4, 5/6, 7/8
Scrambler	Let the user enable the scrambler
Interleaver	Let the user enable the interleaver
ASI port	Let the user select ASI input between ASI 1, ASI 2, ASI BUS 1 and ASI BUS 2

9.4 Rear Panel.

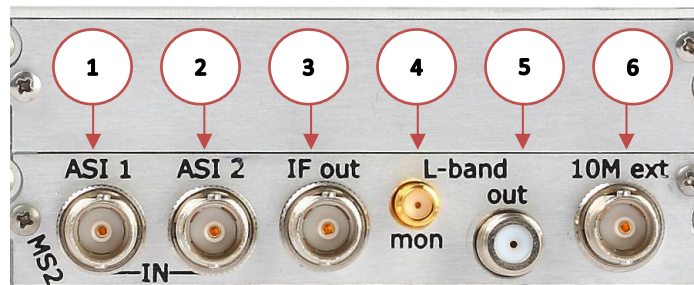

FIGURE 64: MS2 BACK PANEL DETAIL.

TABLE 90: MS2 CONNECTORS DESCRIPTION

Tag	Description	Function
1	ASI 1	BNC(f) 75 Ohm; ASI 1 external input
2	ASI 2	BNC(f) 75 Ohm; ASI 2 external input
3	IF out	BNC(f) 75 Ohm; IF 70 MHz output

MS2 Modulator Board

4	L-band mon	SMA(f) 75 Ohm;
5	L-band out	F(f) 75 Ohm;
6	10M ext	BNC(f) 75 Ohm; 10 MHz reference input.